

IGBT MODULE (L series)

■ Features

- High Speed Switching
- Low Saturation Voltage
- Voltage Drive

■ Applications

- Inverter for Motor Drive
- AC and DC Servo Drive Amplifier
- Uninterruptible Power Supply
- Industrial Machines, such as Welding Machines

■ Maximum Ratings and Characteristics

● Absolute Maximum Ratings

Items	Symbols	Ratings	Units
Collector-Emitter Voltage	V_{CES}	600	V
Gate-Emitter Voltage	V_{GES}	± 20	V
Collector Current	Continuous	I_c	150
	1ms	$I_{c\ pulse}$	300
	Continuous	$-I_c$	150
	1ms	$-I_{c\ pulse}$	300
Max. Power Dissipation	P_c	600	W
Operating Temperature	T_j	+150	°C
Storage Temperature	T_{stg}	-40 to +125	°C
Net. Weight		340	g
Isolation Voltage	AC. 1min.	V_{isol}	2500
Screw Torque	Mounting *1	35	kg*cm
	Terminals *1	35	

*1 Recommendable Value 25 to 35kg*cm (M5)

● Electrical Characteristics ($T_j=25^\circ\text{C}$)

Items	Symbols	Test Conditions	Min.	Typ.	Max.	Units
Zero Gate Voltage Collector Current	I_{CES}	$V_{GE}=0V$ $V_{CE}=600V$ $T_j=25^\circ\text{C}$			2.0	mA
Gate-Emitter Leakage Current	I_{GES}	$V_{CE}=0V$ $V_{GE}=\pm 20V$			200	nA
Gate-Emitter Threshold Voltage	$V_{GE(th)}$	$V_{CE}=20V$ $I_c=150mA$	3.0		6.0	V
Collector-Emitter Saturation Voltage	$V_{CE(sat)}$	$V_{GE}=15V$ $I_c=150A$			3.5	V
Input Capacitance	C_{ies}	$V_{GE}=0V$		14250		pF
Output Capacitance	C_{oes}	$V_{CE}=10V$		-		
Reverse Transfer Capacitance	C_{res}	$f=1MHz$		-		
Turn-on Time *2	t_{on}	$V_{CC}=300V$		0.6	0.8	μs
	t_r	$I_c=150A$		0.4	0.6	
Turn-off Time *3	t_{off}	$V_{GE}=\pm 15V$		0.7	1.0	
	t_f	$R_G=12\Omega$		0.2	0.35	
Diode Forward On-Voltage	V_F	$I_F=150A$ $V_{GE}=0V$			2.5	V
Reverse Recovery Time	t_{rr}	$I_F=150A$ $-di/dt=450A/\mu\text{s}$ $V_{GE}=-10V$			300	ns

*2 Resistive load

*3 Inductive load

● Thermal Characteristics

Items	Symbols	Test Conditions	Min.	Typ.	Max.	Units
Thermal Resistance	$R_{th(j-c)}$	IGBT			0.208	°C/W
	$R_{th(j-d)}$	Diode			0.40	
	$R_{th(c-f)}$	With Thermal compound		0.025		

■ Outline Drawings

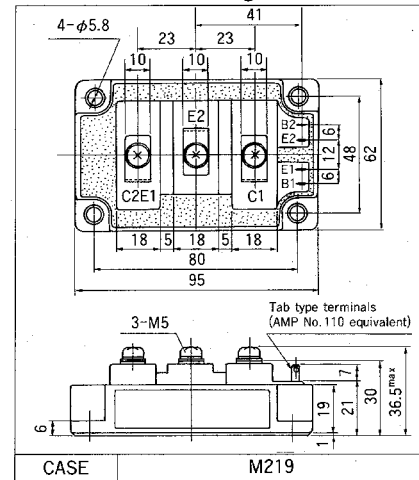

■ Equilavent Circuit Schematic

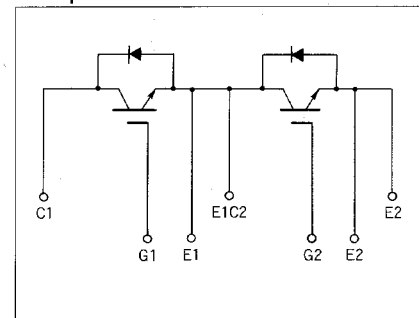

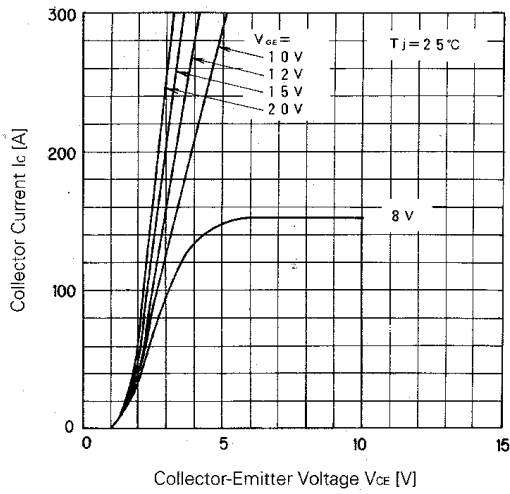

Collector Current vs. Collector-Emitter Voltage

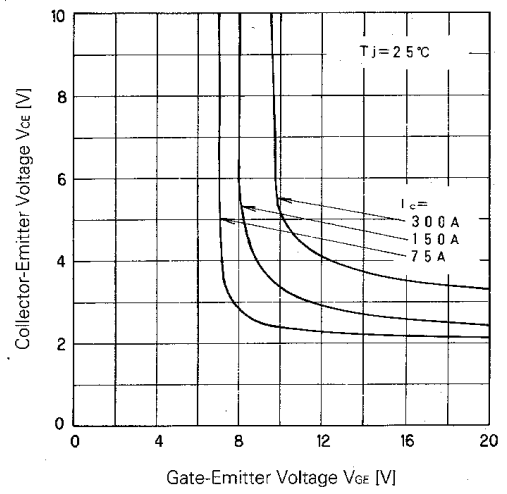

Collector-Emitter Voltage vs. Gate-Emitter Voltage

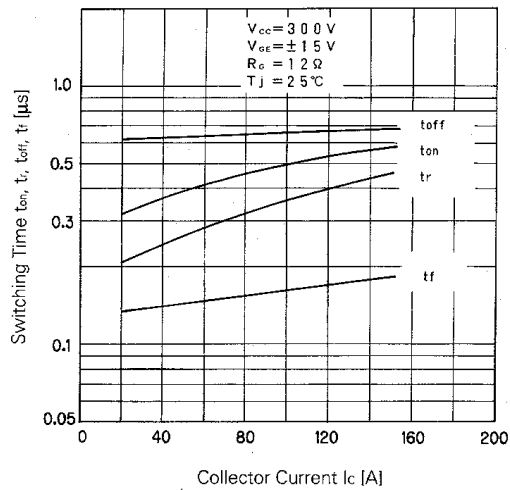

Switching Time

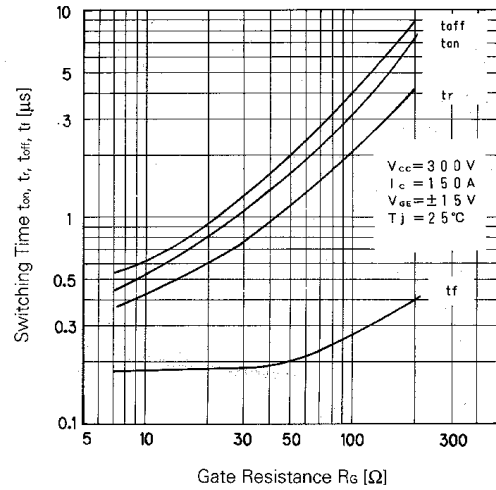

Switching Time-Gate Resistance

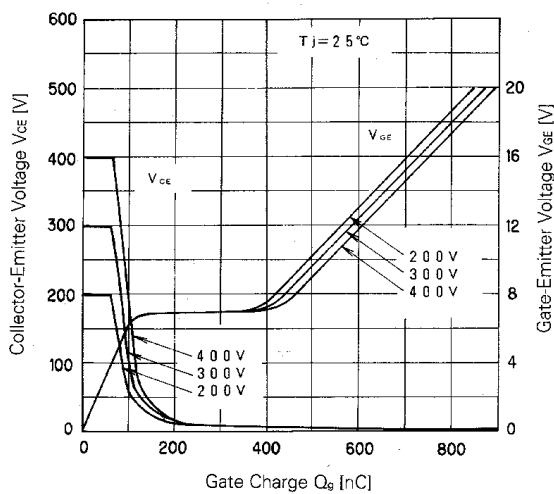

Dynamic Input Characteristic

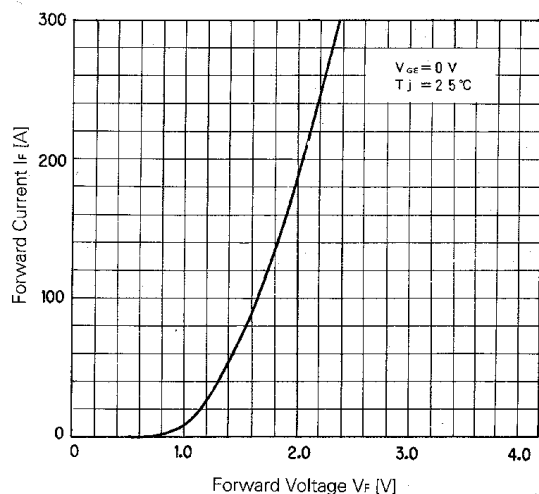

Forward Voltage of Free Wheel Diode

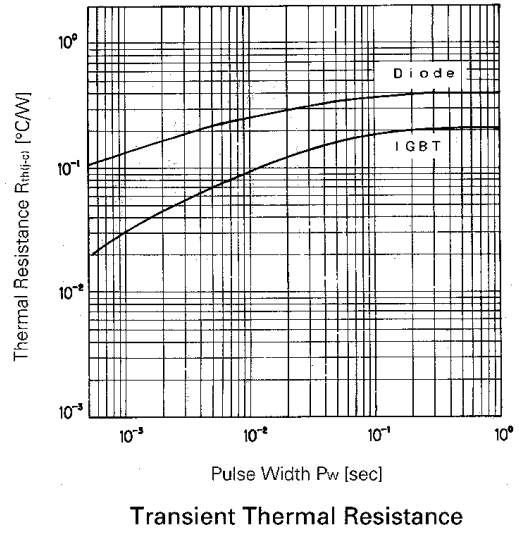
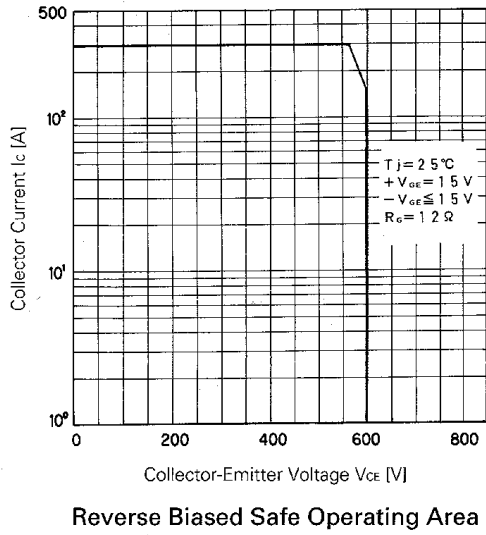
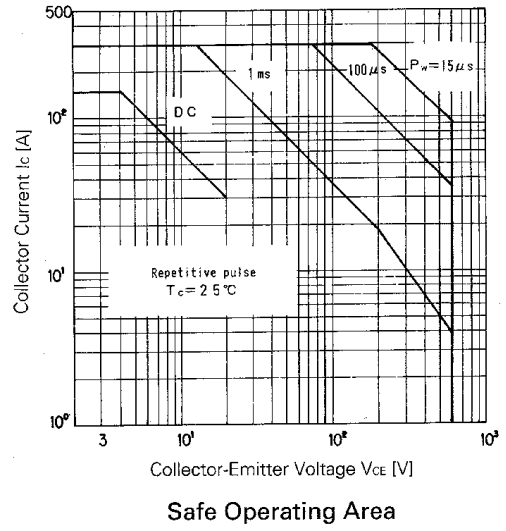
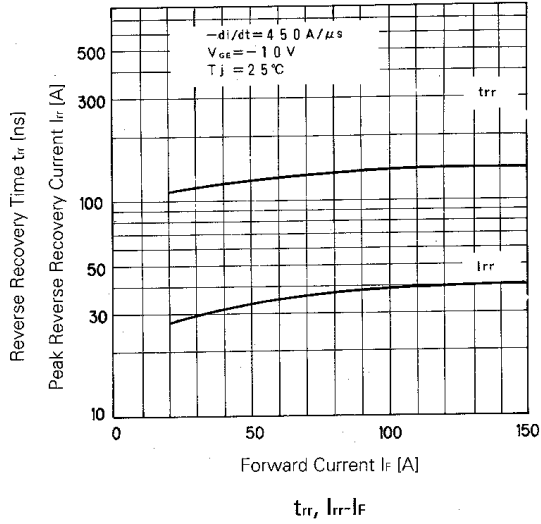

For more information, contact:

Collmer Semiconductor, Inc.

P.O. Box 702708

Dallas, TX 75370

972-733-1700

972-381-9991 Fax

<http://www.collmer.com>